

DSE5

DIRECTIONAL VALVE WITH PROPORTIONAL CONTROL

SERIES 10

SUBPLATE MOUNTING ISO 4401-05

p max 320 bar
Q max 90 l/min

MOUNTING INTERFACE

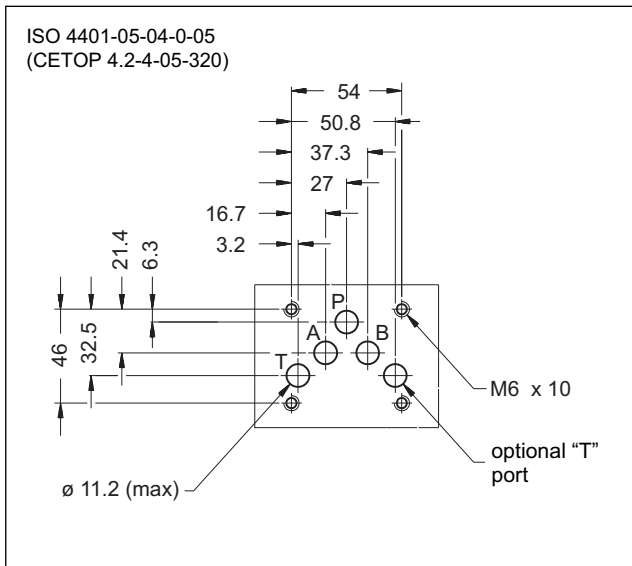

PERFORMANCES

(obtained with mineral oil with viscosity of 36 cSt at 50°C and electronic control card)

Maximum operating pressure: - P - A - B ports - T port : standard version version with Y port	bar	320 210 320
Maximum flow with Δp 10 bar P-T	l/min	30 - 60
Step response	see paragraph 6	
Hysteresis (with PWM 100 Hz)	% of Q max	< 6%
Repeatability	% of Q max	< $\pm 1,5\%$
Electrical characteristics	see paragraph 5	
Ambient temperature range	°C	-20 / +60
Fluid temperature range	°C	-20 / +80
Fluid viscosity range	cSt	10 ÷ 400
Fluid contamination degree	According to ISO 4406:1999 class 18/16/13	
Recommended viscosity	cSt	25
Mass: single solenoid valve double solenoid valve	kg	4,4 5,9

OPERATING PRINCIPLE

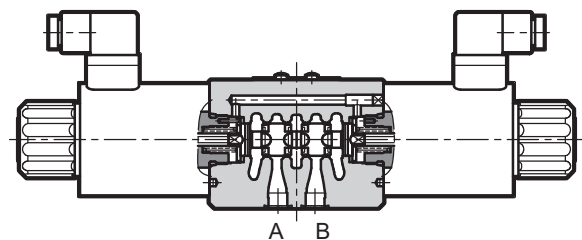

- The DSE5 valve is a directly operated directional control valve with electric proportional control and with ports in compliance with ISO 4401 standards.
- It is used for directional and speed control of the hydraulic actuators.
- Valve opening and hence flow rate can be modulated continuously in proportion to the current supplied to the solenoid.
- The valve can be controlled directly by a current control supply unit or by means of the relative electronic control units to exploit valve performance to the full (see paragraph 11).
- Other two versions with external subplate drain port are available (see paragraph 9).

HYDRAULIC SYMBOLS (typical)

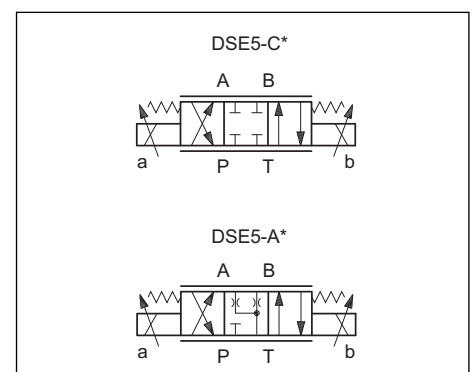

1 - IDENTIFICATION CODE

D	S	E	5	-					/ 10	-			/	
----------	----------	----------	----------	----------	--	--	--	--	-------------	----------	--	--	----------	--

Directly operated directional control valve

Electric proportional control

Size ISO 4401-05

Spool type:
C = closed centers
A = open centers

Spool nominal flow (see table 2)

Solenoid position (omit for configuration with two solenoids):
SA = 1 solenoid on side A
SB = 1 solenoid on side B

Option:
/ W7 = Zinc-nickel surface treatment (see **NOTE**)
 Omit if not required

Option: manual override (see at par. 9)

Coil electrical connection:
 plug for connector type
 DIN 43650 (**standard**)

D12 = Nominal solenoid voltage 12V DC
D24 = Nominal solenoid voltage 24V DC

Seals:
N = NBR seals for mineral oil (**standard**)
V = FPM seals for special fluids

Series No. (from 10 to 19 sizes and mounting dimensions remain unchanged)

NOTE: The standard valve is supplied with surface treatment of phosphating black.

The zinc-nickel finishing makes the valve suitable to ensure a salt spray resistance up to 240 hours (test operated according to EN ISO 9227 standards and test evaluation operated according to UNI EN ISO 10289 standards).

2 - CONFIGURATIONS

Valve configuration depends on the combination of the following elements:
 number of proportional solenoids, spool type, nominal flow rate.

2 solenoids configuration:
 3 positions with spring centering

"SA" configuration: 1 solenoid on side A.
 2 positions (central + external) with spring centering

"SB" configuration: 1 solenoid on side B.
 2 positions (central + external) with spring centering

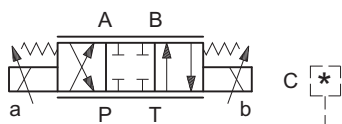
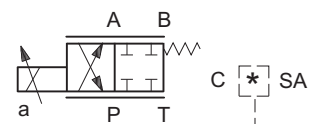
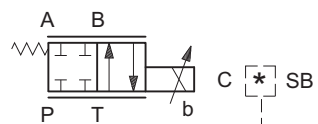
*	Controlled flow with Δp 10 bar P-T
30	30 l/min
60	60 l/min
60/30	60 (P-A) / 30 (B-T) l/min

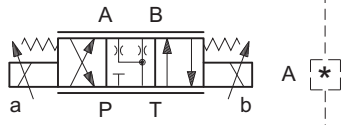
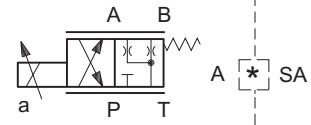
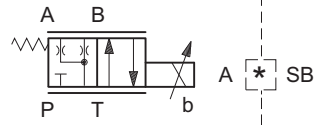
3 - CHARACTERISTIC CURVES

(values measured with oil viscosity of 36 cSt at 50°C and with electronic control unit)

Typical constant flow rate control curves at Δp according to current supply to solenoid (D24 version, maximum current 1600 mA), measured for the various spools types available.

The reference Δp values are measured between ports P and T on the valve.

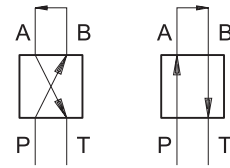

SPOOL TYPE C30

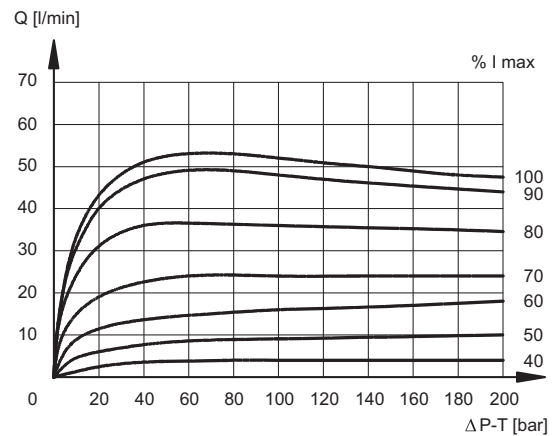
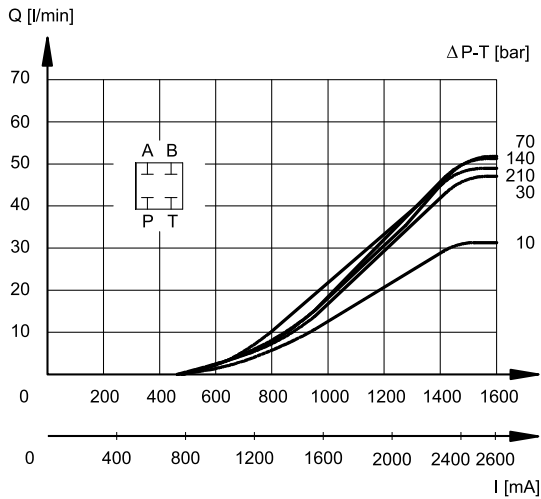

SPOOL TYPE C60

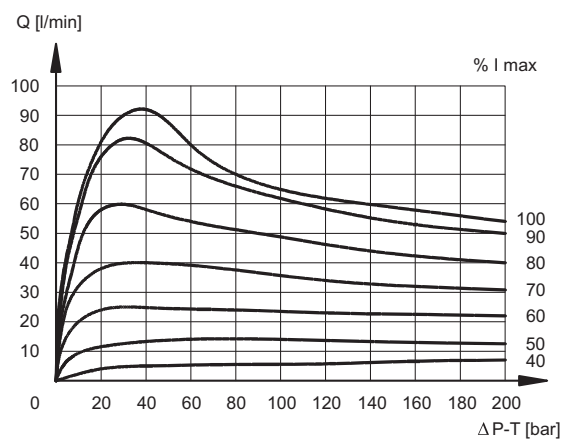
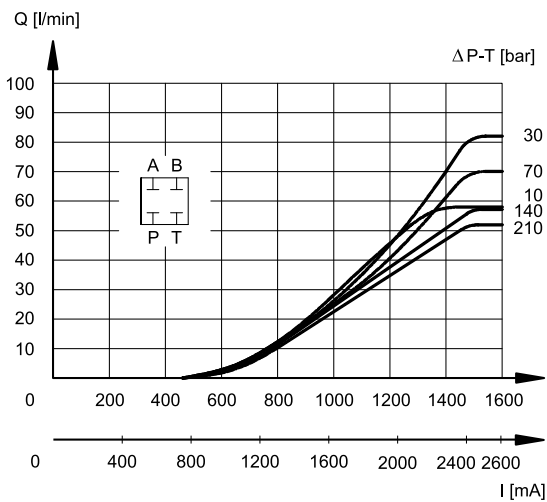

SPOOL TYPE A30

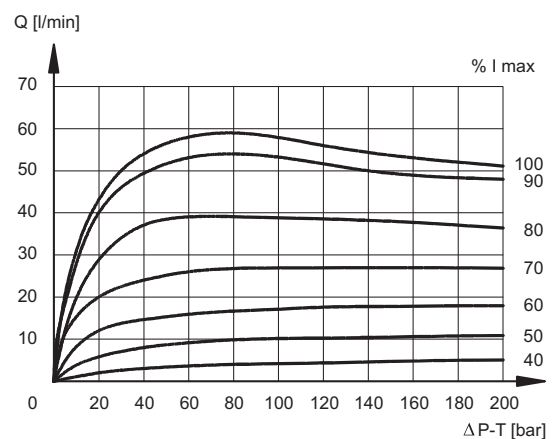
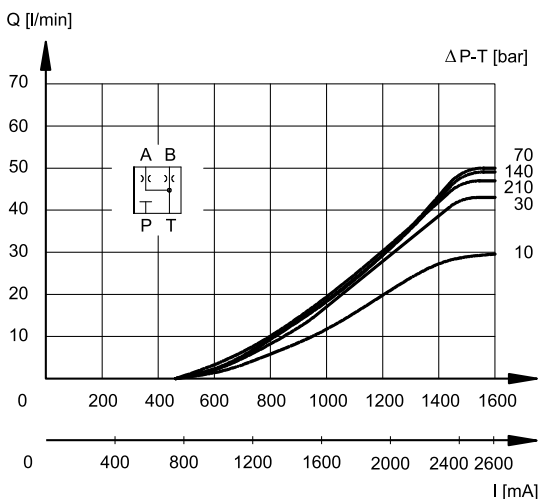



SPOOL TYPE A60

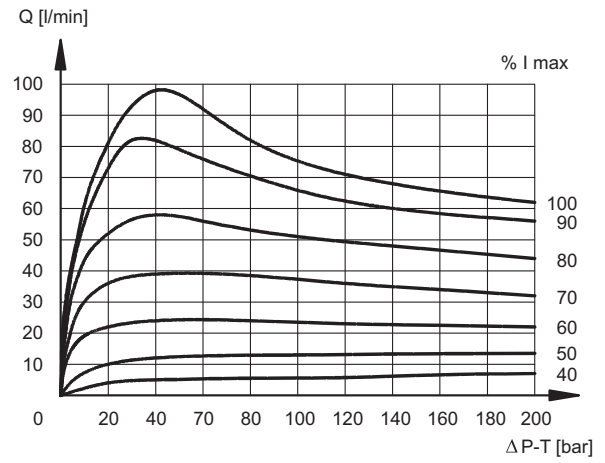
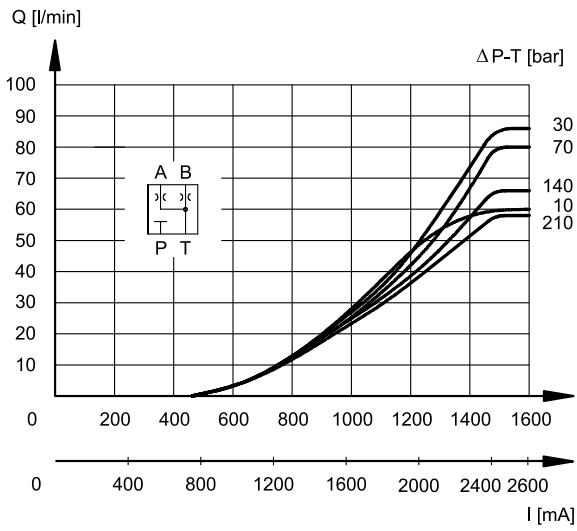

4 - HYDRAULIC FLUIDS

Use mineral oil-based hydraulic fluids HL or HM type, according to ISO 6743-4. For these fluids, use NBR seals (code N). For fluids HFDR type (phosphate esters) use FPM seals (code V). For the use of other fluid types such as HFA, HFB, HFC, please consult our technical department. Using fluids at temperatures higher than 80 °C causes a faster degradation of the fluid and of the seals characteristics. The fluid must be preserved in its physical and chemical characteristics.

5 - ELECTRICAL CHARACTERISTICS

Proportional solenoid

The proportional solenoid comprises two parts: tube and coil. The tube, screwed to the valve body, contains the armature which is designed to maintain friction to a minimum thereby reducing hysteresis. The coil is mounted on the tube secured by means of a lock nut. It can be rotated through 360° depending on installation clearances.

NOMINAL VOLTAGE	VDC	12	24
RESISTANCE (at 20°C)	Ω	3 - 3.4	8.65
MAXIMUM CURRENT	A	2.6	1.6
DUTY CYCLE	100%		
ELECTROMAGNETIC COMPATIBILITY (EMC)	according to 2004/108/EC		
CLASS OF PROTECTION: atmospheric agents (IEC 60529) coil insulation (VDE 0580) Impregnation	IP 65 class H class F		

6 - STEP RESPONSE

(measured with mineral oil with viscosity of 36 cSt at 50°C and with electronic control unit)

Step response is the time taken for the valve to reach 90% of the set position value following a step change of reference signal. The table shows typical response times tested with spool type C60 and $\Delta p = 20$ bar P-T.

REFERENCE SIGNAL STEP	0→100%	100%→0
Step response [ms]		
DSE5-A* DSE5-C*	50	40

7 - INSTALLATION

DSE5 valves can be installed in any position without impairing correct operation.

Ensure that there is no air in the hydraulic circuit.

Valves are fixed by means of screws or tie rods on a flat surface with planarity and roughness equal to or better than those indicated in the relative symbols. If minimum values are not observed fluid can easily leak between the valve and support surface.

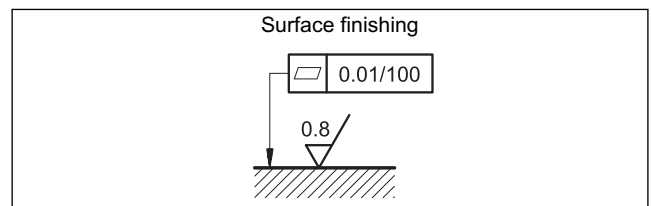

8 - OVERALL AND MOUNTING DIMENSIONS

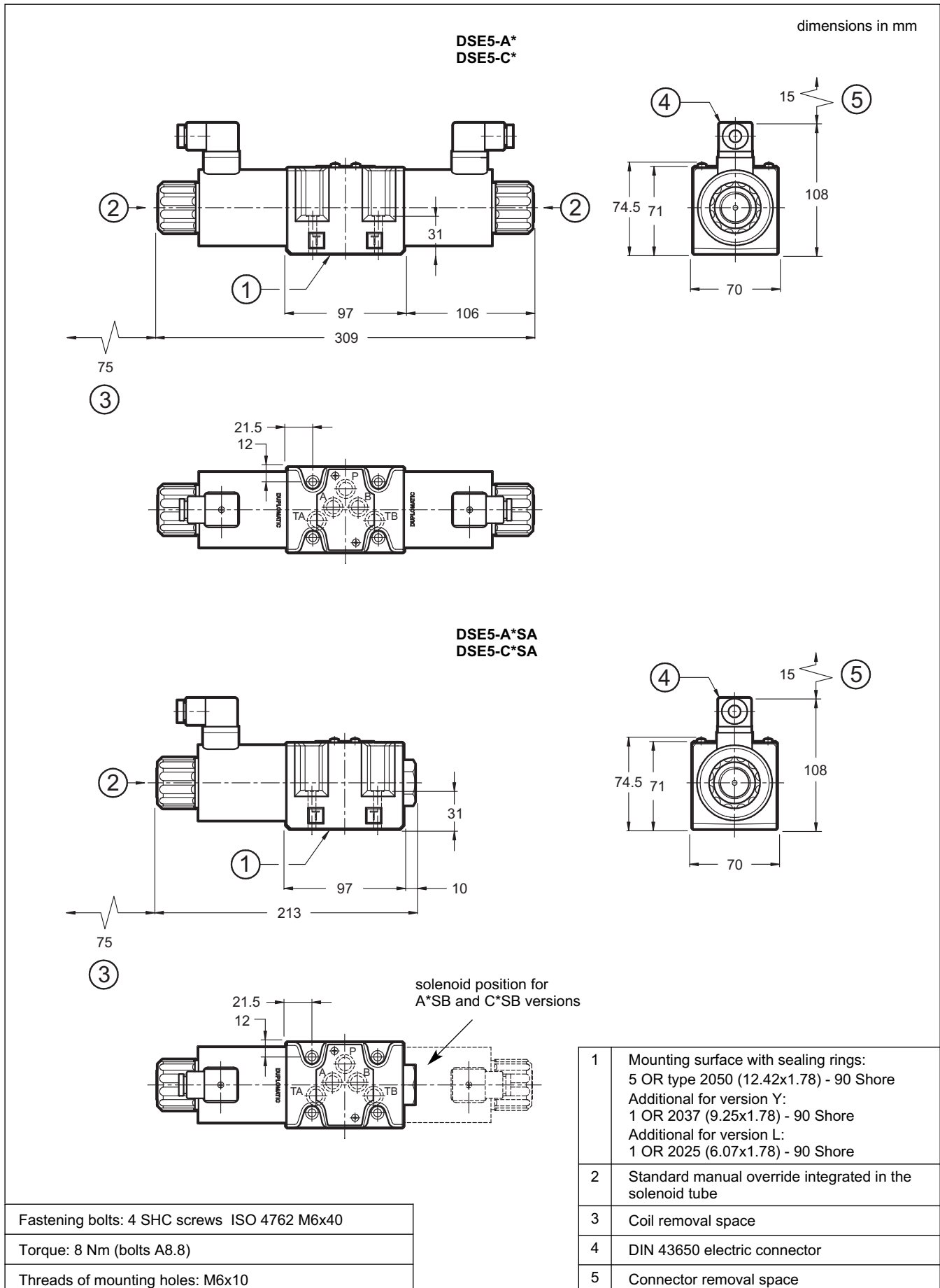

9 - VERSIONS WITH EXTERNAL DRAIN PORT

9.1 - Identification Code

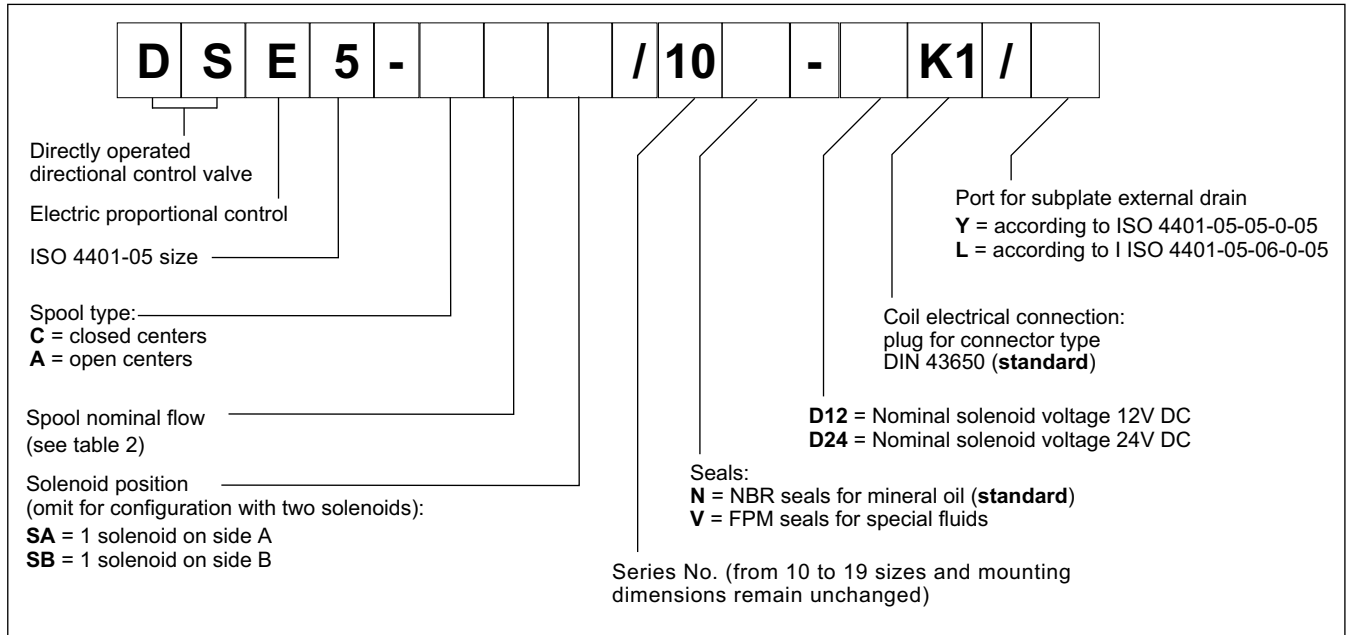

These versions allow the operation with pressures up to 320 bar on T port of the valve .

The additional drain port is connected with the solenoid chamber: in this way the tubes are not stressed by the pressure operating on the T port of the valve.

9.2 - Y Version

The drain port Y is realized on the valve mounting surface in compliance with ISO 4401-05-05-0-05 standard.

There is no X port.

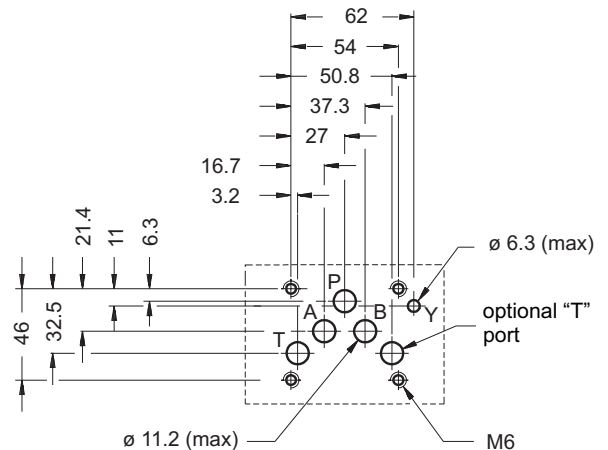

9.3 - L version

It consists of a drain port on the mounting surface of the valve according to ISO 4401-05-06-0-05 standard

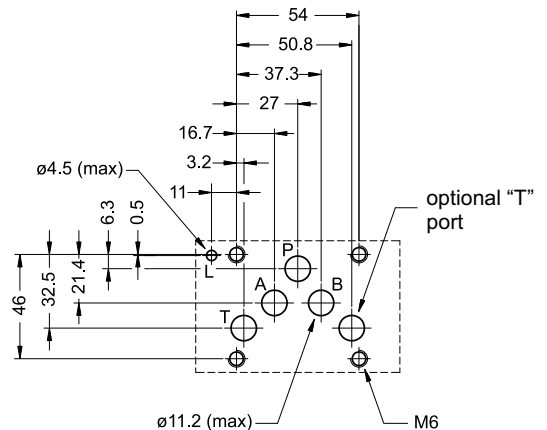

10 - MANUAL OVERRIDE

The standard valve has solenoids whose pin for the manual operation is integrated in the tube. The operation of this control must be executed with a suitable tool, minding not to damage the sliding surface.

The following manual override is available upon request:

- **CK** version, knob. When the set screw is screwed and its point is aligned with the edge of the knob, tighten the knob till it touches the spool: in this position the override is not engaged and the valve is de-energized. After adjusting the override, tighten the set screw in order to avoid the knob loosening.

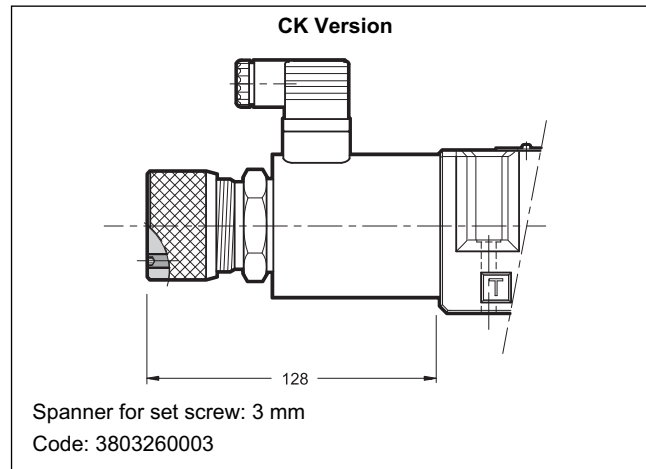

11 - ELECTRONIC CONTROL UNITS

DSE5- **SA (SB)

EDC-131	for solenoid 24V DC	plug version	see catalogue 89 120
EDC-151	for solenoid 12V DC		
EDM-M131	for solenoid 24V DC	DIN EN 50022 rail mounting	see catalogue 89 250
EDM-M151	for solenoid 12V DC		

DSE5- A* DSE5-C*

EDM-M231	for solenoid 24V DC	DIN EN 50022 rail mounting	see catalogue 89 250
EDM-M251	for solenoid 12V DC		

12 - SUBPLATES

(see cat. 51 000)

Type PMD4-AI4G with rear ports 3/4" BSP
Type PMD4-AL4G with side ports 1/2" BSP