

DZCE*G

PRESSURE REDUCING VALVE WITH PROPORTIONAL CONTROL AND INTEGRATED ELECTRONICS

SERIES 12

DZCE5G **CETOP P05**
DZCE5RG **ISO 4401-05 (CETOP R05)**
DZCE7G **ISO 4401-07 (CETOP 07)**
DZCE8G **ISO 4401-08 (CETOP 08)**

p max **350** bar

Q max (see performance table)

OPERATING PRINCIPLE

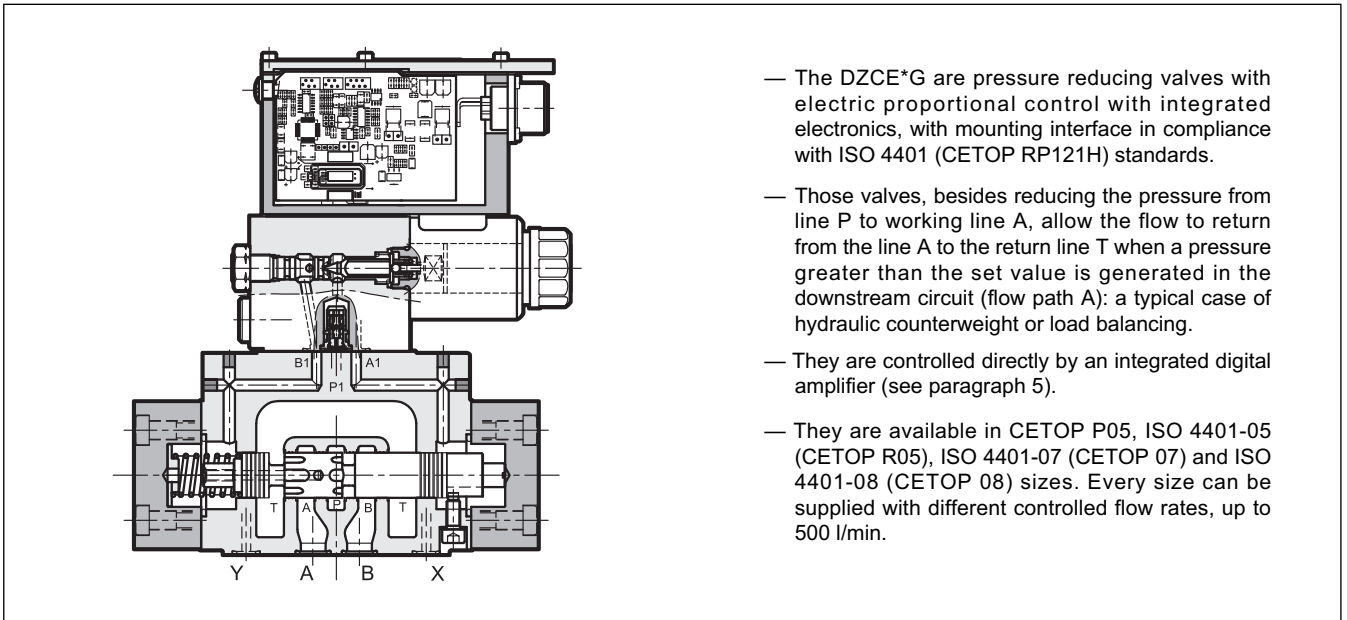

PERFORMANCES

(obtained with mineral oil with viscosity of 36 cSt at 50°C)

		DZCE5G DZCE5RG	DZCE7G	DZCE8G
Max operating pressure	bar	350		
Maximum flow	l/min	150	300	500
Step response		see paragraph 4		
Hysteresis	% of p_{max}	< 2%		
Repeatability	% of p_{max}	< ±2%		
Electrical characteristics		see paragraph 5		
Ambient temperature range	°C	-20 / +60		
Fluid temperature range	°C	-20 / +80		
Fluid viscosity range	cSt	10 + 400		
Fluid contamination degree		According to ISO 4406:1999 class 18/16/13		
Recommended viscosity	cSt	25		
Mass	kg	7,3	9,5	15,6

HYDRAULIC SYMBOL

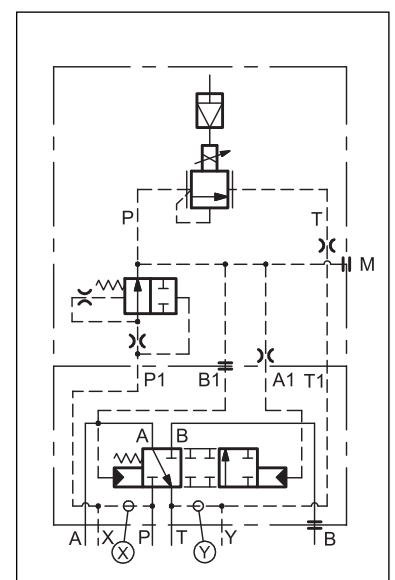

1 - IDENTIFICATION CODE

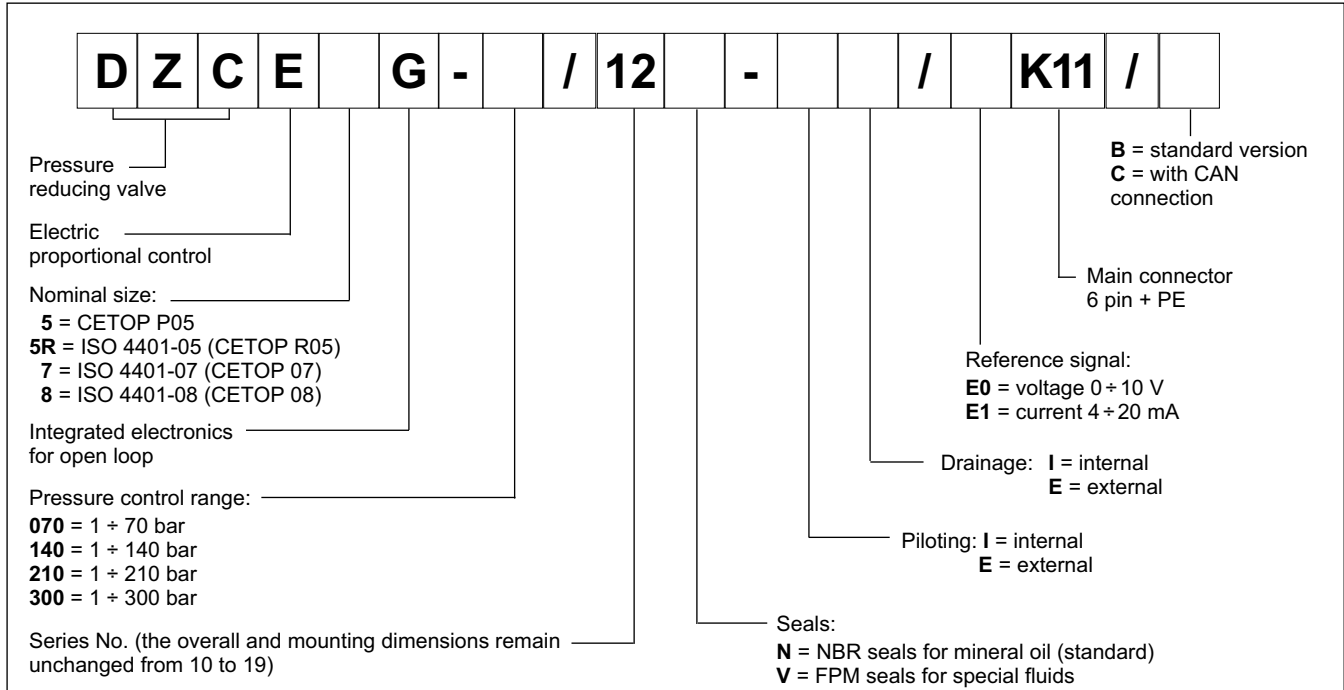

2 - CHARACTERISTIC CURVES

(with mineral oil with viscosity of 36 cSt at 50°C)

2.1 - Characteristic Curves of DZCE5G and DZCE5RG

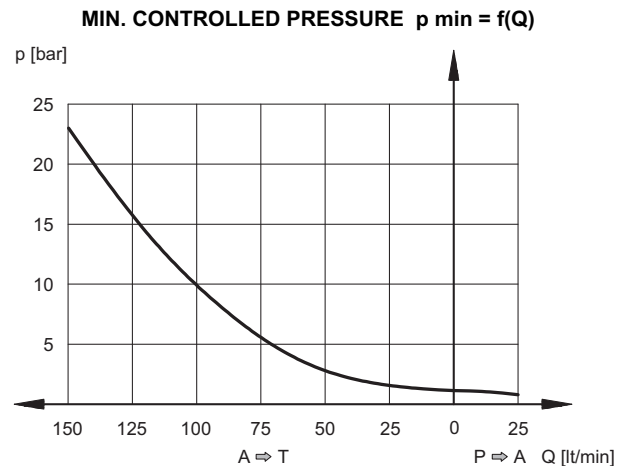
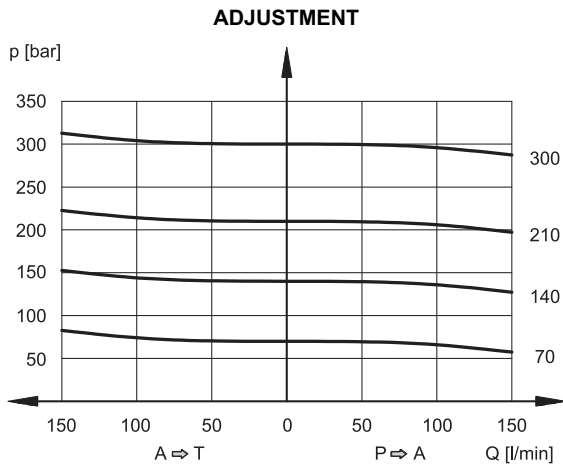

2.2 - Characteristic Curves of DZCE7G

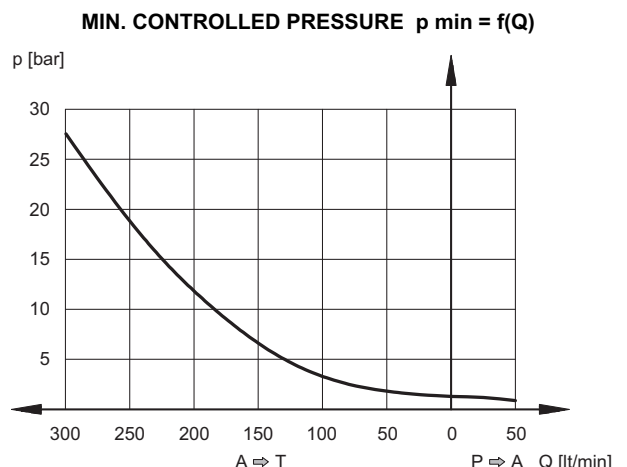
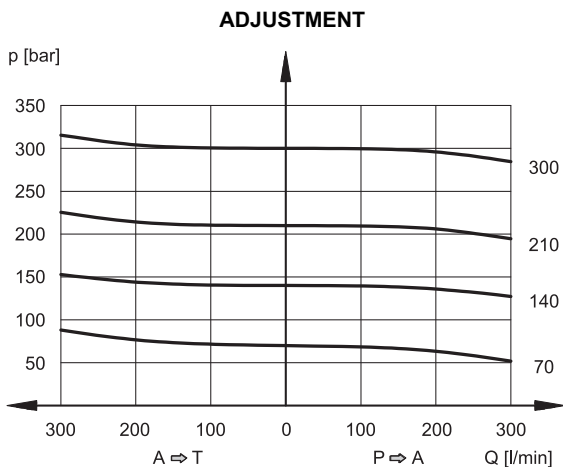

2.3 - Characteristic Curves of DZCE8G

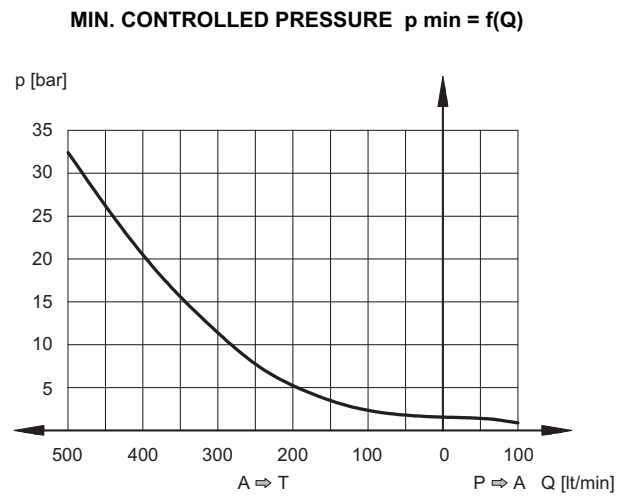
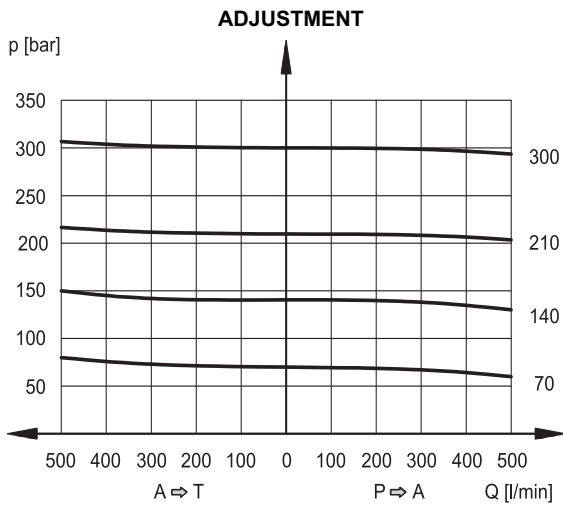

2.4 - CONTROLLED PRESSURE $p = f(I)$

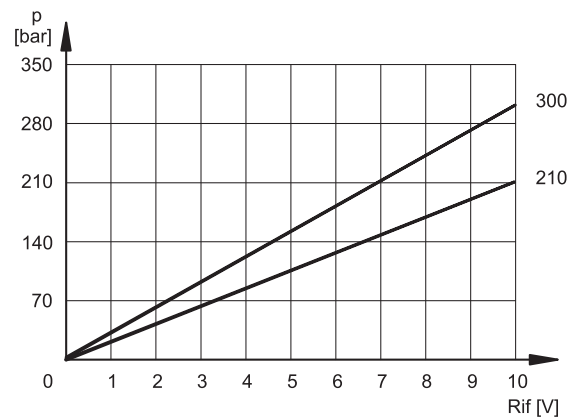
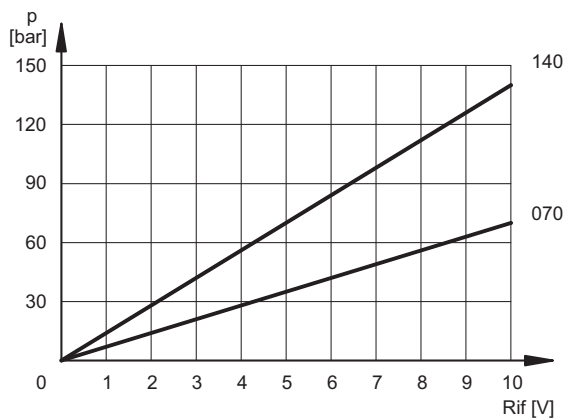

3 - HYDRAULIC FLUIDS

Use mineral oil-based hydraulic fluids HL or HM type, according to ISO 6743-4. For these fluids, use NBR seals. For fluids HFDR type (phosphate esters) use FPM seals (code V). For the use of other kinds of fluid such as HFA, HFB, HFC, please consult our technical department. Using fluids at temperatures higher than 80 °C causes a faster degradation of the fluid and of the seals characteristics.

The fluid must be preserved in its physical and chemical characteristics.

4 - STEP RESPONSE

(obtained with mineral oil with viscosity of 36 cSt at 50°C and with digital integrated electronics)

The graphs show the typical step response tested with static pressure 100 bar.

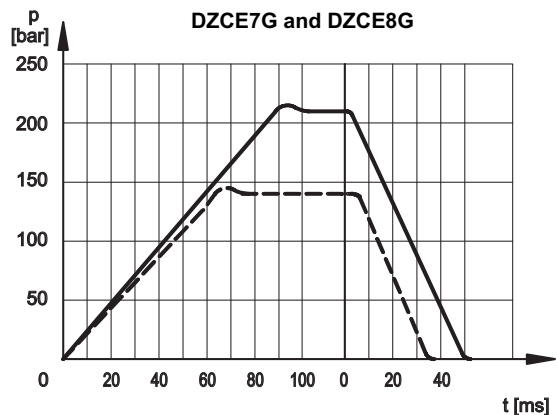
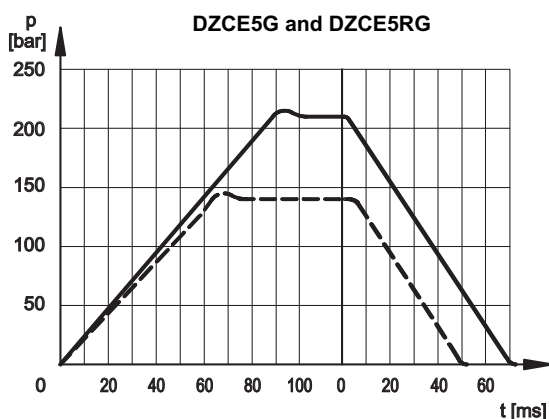

5 - ELECTRICAL CHARACTERISTICS

5.1 - Digital integrated electronics

The proportional valve is controlled by a digital amplifier (driver), which incorporates a microprocessor that controls, via software, all the valve functions, such as:

- continuous converting (0,5ms) of the voltage reference signal (E0) or of the current reference signal (E1) in a digital value
- generation of up and down ramps (see **NOTE**)
- gains limit (see **NOTE**)
- compensation of the dead band
- linearization of the characteristic curve
- regulation of the current to the solenoid
- dynamic regulation of PWM frequency
- protection of the solenoid outputs against possible short circuits

The digital driver enables the valve to reach better performance compared to the analogic version, such as:

- reduced hysteresis and better repeatability
- reduced response times
- linearization of the characteristic curve which is optimised in factory for each valve
- complete interchangeability in case of valve replacement
- possibility to set, via software, the functional parameters
- possibility to interface a CAN-Open network
- possibility to perform a diagnostic program by means of the CAN connection
- high immunity to electromagnetic troubles

NOTE: these parameters can be set through the connection to the CAN connector, by means of a personal computer and relevant software (see par. 6.3)

5.2 - Functional block diagram

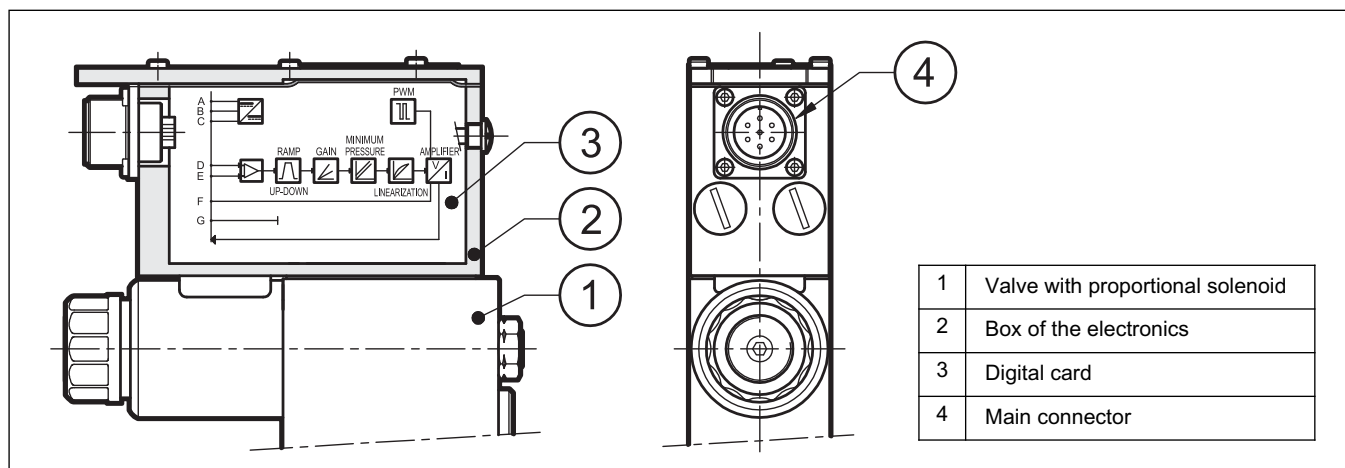

5.3 - Electrical characteristics

NOMINAL VOLTAGE	V DC	24 (from 19 to 35 VDC, ripple max 3 Vpp)
ABSORBED POWER	W	50
MAXIMUM CURRENT	A	1,88
DUTY CYCLE		100%
VOLTAGE SIGNAL (E0)	V DC	0 ÷ 10 (Impedance Ri > 50KΩ)
CURRENT SIGNAL (E1)	mA	4 ÷ 20 (Impedance Ri = 500 Ω)
ALARMS		Overload and electronics overheating
COMMUNICATION		Interface of the optoisolated industrial Field-bus type CAN-Bus ISO 11898
MAIN CONNECTOR		7 - pin MIL-C-5015-G (DIN 43563)
CAN-BUS CONNECTOR		M12-IEC 60947-5-2
ELECTROMAGNETIC COMPATIBILITY (EMC) emissions IEC EN 61000-6-4 immunity IEC EN 61000-4-2		According to 2004/108/CE standards
PROTECTION AGAINST ATMOSPHERIC AGENTS :		IP65 / IP67 (IEC EN 60529 standards)

6 - OPERATING MODALITIES

The digital driver of DZCE*G valve may be used with different functions and operating modalities, depending on the requested performances.

6.1 - Version with voltage reference signal (E0)

This is the most common version; it makes the valve completely interchangeable with the traditional proportional valves with analogue type integrated electronics. The valve has only to be connected as indicated below.

This version doesn't allow the setting of the valve parameters, for example the ramps must be performed in the PLC program, as well as the reference signal limit.

E0 Connection scheme

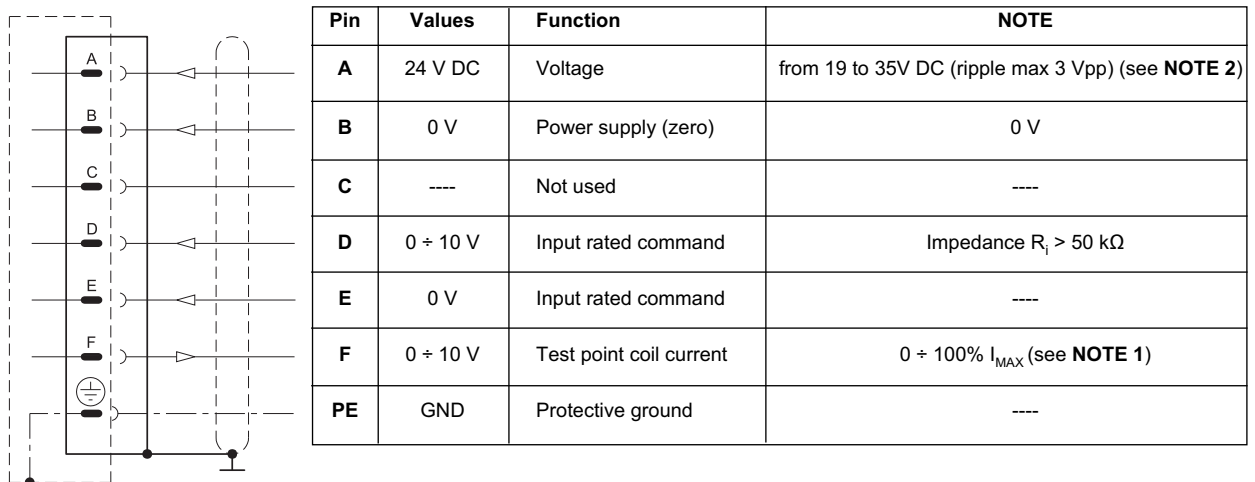

NOTE: if only one input signal is available (single-end), then the pin B (0V power supply) and the pin E (0V reference signal) must be connected through a jumper and both connected to GND, electric panel side.

6.2 - Version with current reference signal (E1)

This version has characteristics which are similar to the previous one, with the difference that in this case the reference signal is supplied in current 4 - 20 mA. With the 4 mA signal the valve is at zero value, while with 20 mA signal the valve is at the maximum setting value.

E1 Connection scheme

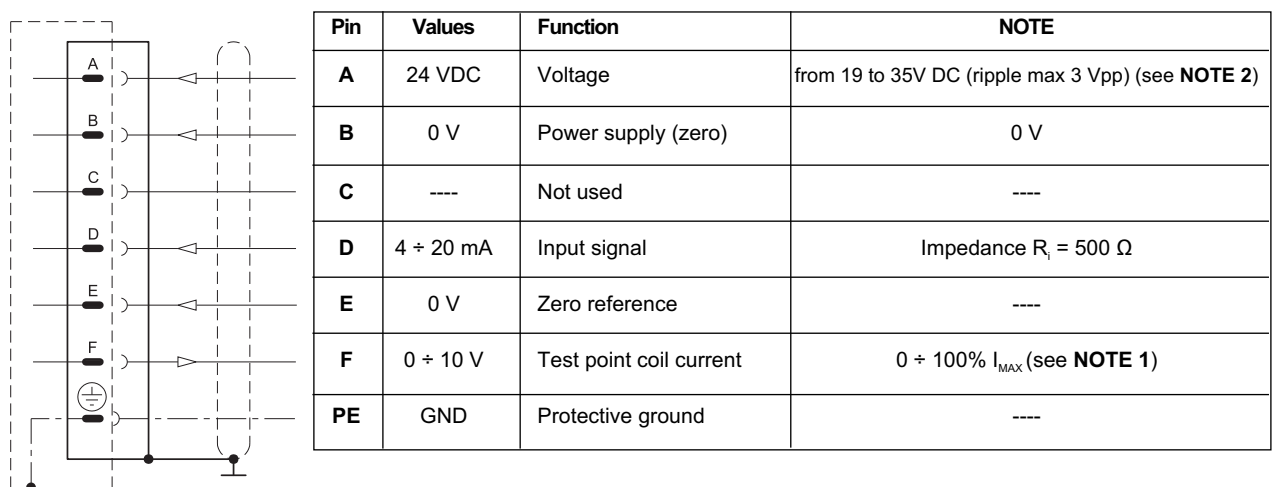

NOTE for the wiring: connections must be made via the 7-pin plug mounted on the amplifier. Recommended cable sizes are 0,75 mm² for cables up to 20 m and 1,00 mm² for cables up to 40m, for power supply. The signal cables must be 0,50 mm². A suitable cable would have 7 cores, a separate screen for the signal wires and an overall screen.

NOTE 1: read the test point pin F in relation to pin B (0V).

NOTE 2: envisage an external fuse on pin A (24V DC) to shield the card. Fuse specifications: 5A/50V fast type.

6.3 - Version C: parameters settings via CAN connector

This version allow to set some parameters of the valve connecting a PC to the CAN connector.

To do this, you have to order the interface device for USB port **CANPC-USB/20** (code 3898101002), that includes the configuration software CANPC-SOF/R001, a communication cable (length 3 mt) and a hardware converter , needed to connect the valve to the USB port. The software is microsoft XP© compliant.

The parameters that can be set are described below:

Nominal pressure

The “nominal pressure” parameter limits the maximum current to the solenoid, therefore it sets the desired nominal pressure corresponding to the positive value of the input reference (10 V or 20 mA).

Default value = 100% of full scale

Range: from 100% to 50% of full scale

PWM Frequency

Sets the PWM frequency, which is the pulsating frequency of the control current. The PWM decrease improves the valve accuracy, decreasing the regulation stability.

The PWM increase improves the regulation stability, causing a higher hysteresis.

Default value = 300 Hz

Range: 50 ÷ 500 Hz

Ramps

Increase time of Ramp R1: sets the current increase time for a variation from 0 to 100% of the input reference.

Decrease time of Ramp R2: sets the current decrease time for a variation from 0 to 100% of the input reference.

Min time = 0,001 sec.

Max time = 40,000 sec.

Default time = 0,001 sec.

Diagnostics

Provides several information parameters, such as:

- The electronic driver status (Working or Broken)
- The active regulation
- Input reference
- Current value

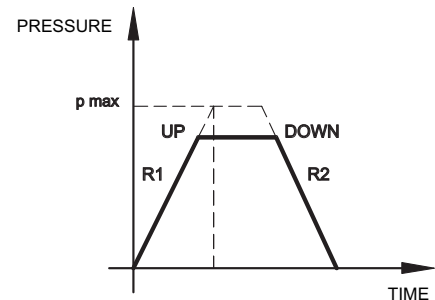
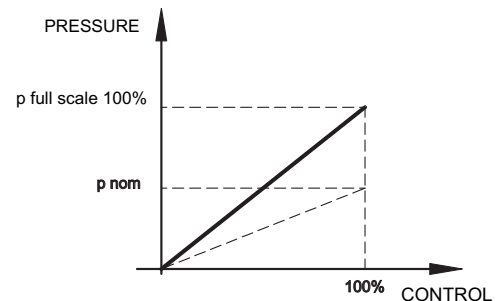

6.4 - Version with CAN-Bus interface (version C)

This version allows the valve piloting through the industrial field bus CAN-Open, according to ISO 11898 standards.

The CAN connector must be connected (see scheme) as a slave node of the CAN-Open bus, while the main connector is wired only for the power supply (pin A and B + earth)

The most important characteristics of a CAN - Open connection are:

- Parameter storage also in PLC
- Parameters setting in real-time (PDO communication)
- On-line valve diagnostics
- Easy wiring with the serial connection
- Communication program according to international standards

For detailed information on the CAN-Open communication software, see cat. 89 800.

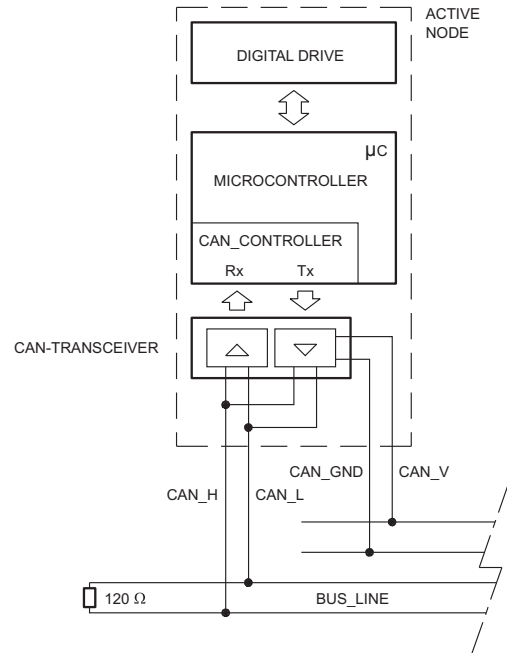

CAN connector connection scheme

Pin	Values	Function
1	CAN_SHLD	monitor
2	CAN +24V DC	BUS + 24 VDC (max 30 mA)
3	CAN 0 DC	BUS 0 VDC
4	CAN_H	BUS line (high signal)
5	CAN_L	BUS line (low signal)

NOTE: insert a 120Ω resistance on pin 4 and pin 5 of the CAN connector when the valve is the end-knot of the CAN network.

7 - INSTALLATION

We recommend to install the DZCE*G valve either in horizontal position, or vertical position with the solenoid downward. If the valve is installed in vertical position and with the solenoid upward, you must consider possible variations of the minimum controlled pressure, if compared to what is indicated in paragraph 2.

Ensure that there is no air in the hydraulic circuit. In particular applications, it can be necessary to vent the air entrapped in the solenoid tube, by using the appropriate drain screw in the solenoid tube. Ensure that the solenoid tube is always filled with oil (see paragraph 8). At the end of the operation, make sure of having correctly replaced the drain screw.

Connect the valve T port directly to the tank. Add any backpressure value detected in the T line to the controlled pressure value. Maximum admissible backpressure in the T line, under operational conditions, is 2 bar.

Valves are fixed by means of screws or tie rods on a flat surface with planarity and roughness equal to or better than those indicated in the relative symbols. If minimum values are not observed, fluid can easily leak between the valve and support surface.

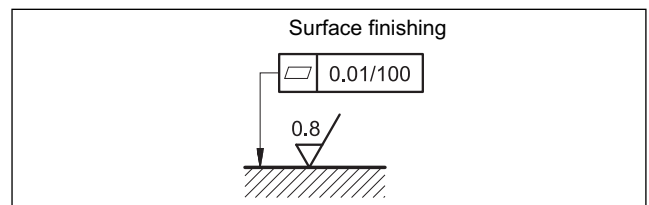

8 - PILOTING AND DRAINAGE

The valves are available with piloting and drainage, both internal and external. The version with external drainage allows a higher backpressure on the unloading.

TYPE OF VALVE	Plug assembly	
	X	Y
IE INTERNAL PILOT AND EXTERNAL DRAIN	NO	YES
II INTERNAL PILOT AND INTERNAL DRAIN	NO	NO
EE EXTERNAL PILOT AND EXTERNAL DRAIN	YES	YES
EI EXTERNAL PILOT AND INTERNAL DRAIN	YES	NO

DZCE5 and DZCE5RG

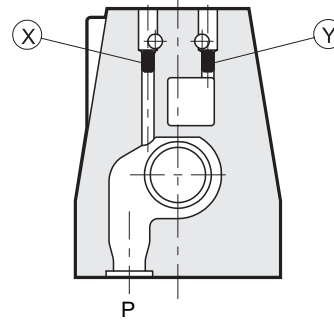

X: M5x6 plug for external pilot
Y: M5x6 plug for external drain

P

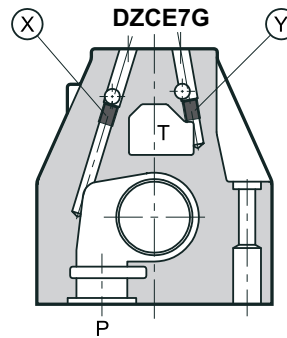

X: M6x8 plug for external pilot
Y: M6x8 plug for external drain

P

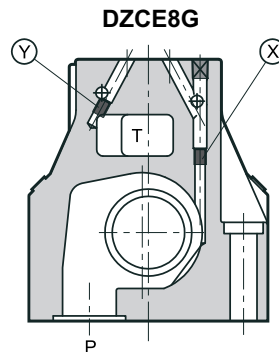

X: M6x8 plug for external pilot
Y: M6x8 plug for external drain

P

9 - OVERALL AND MOUNTING DIMENSIONS DZCE5G AND DZCE5RG

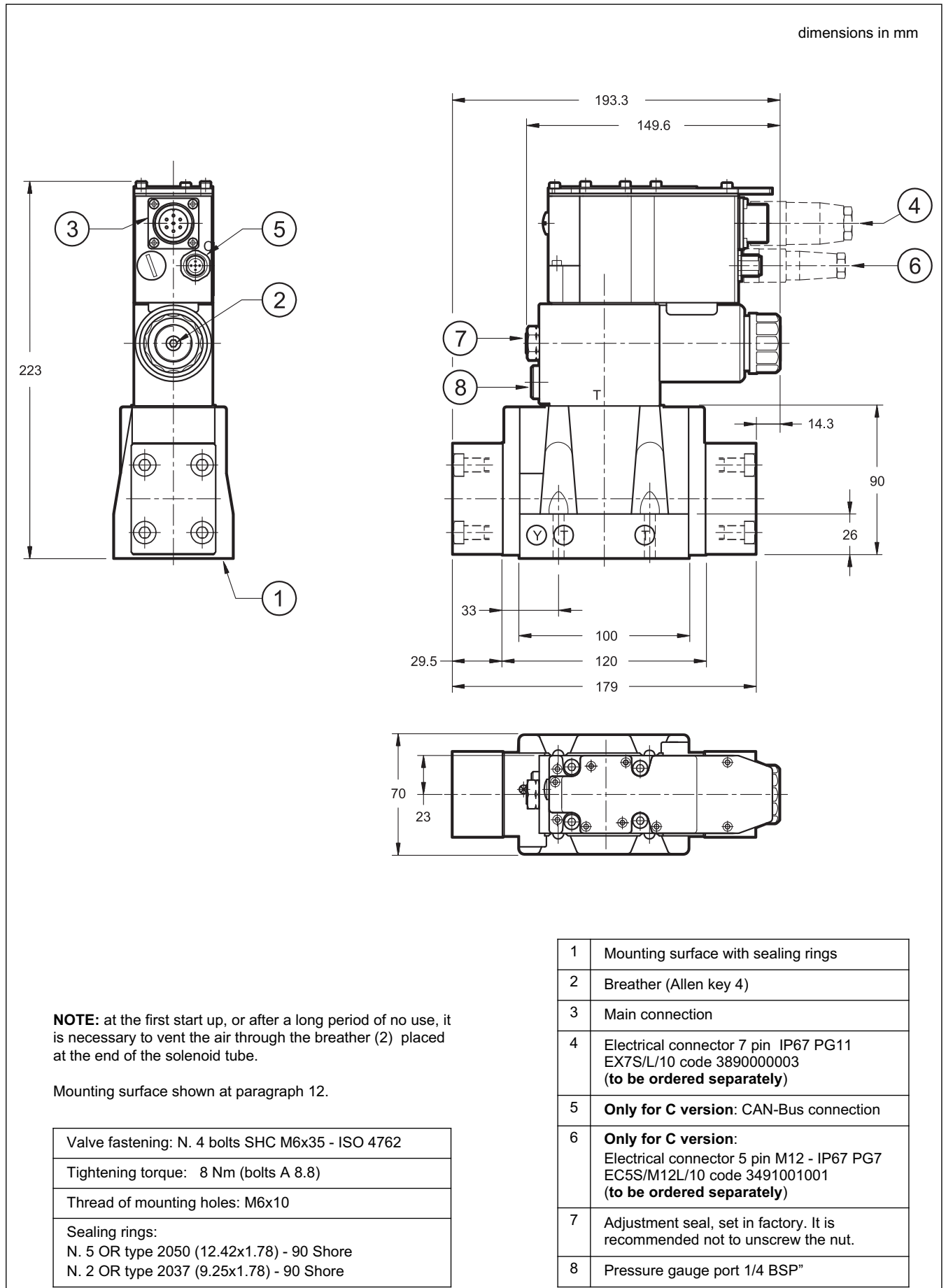

10 - OVERALL AND MOUNTING DIMENSIONS DZCE7G

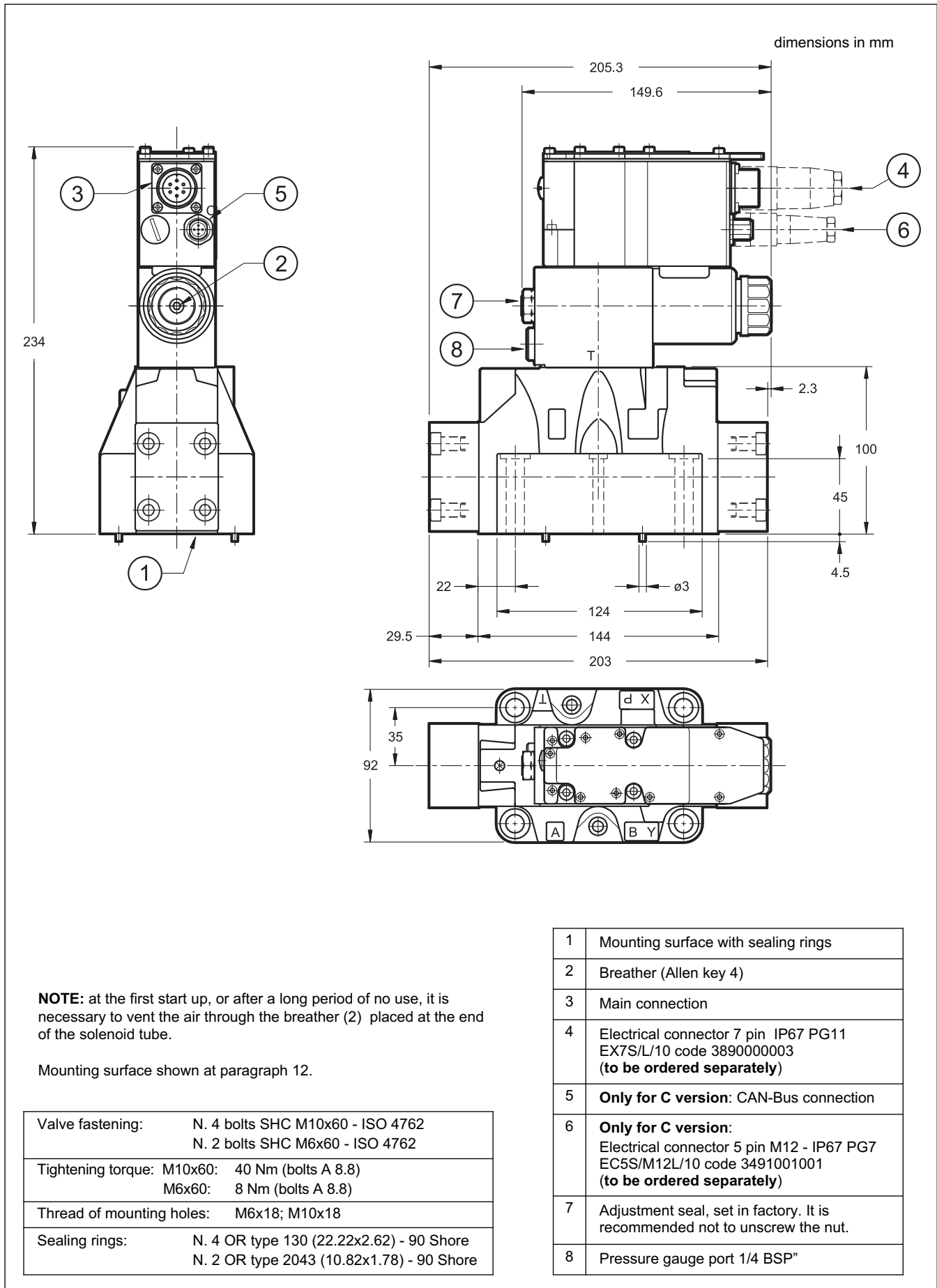

11 - OVERALL AND MOUNTING DIMENSIONS DZCE8G

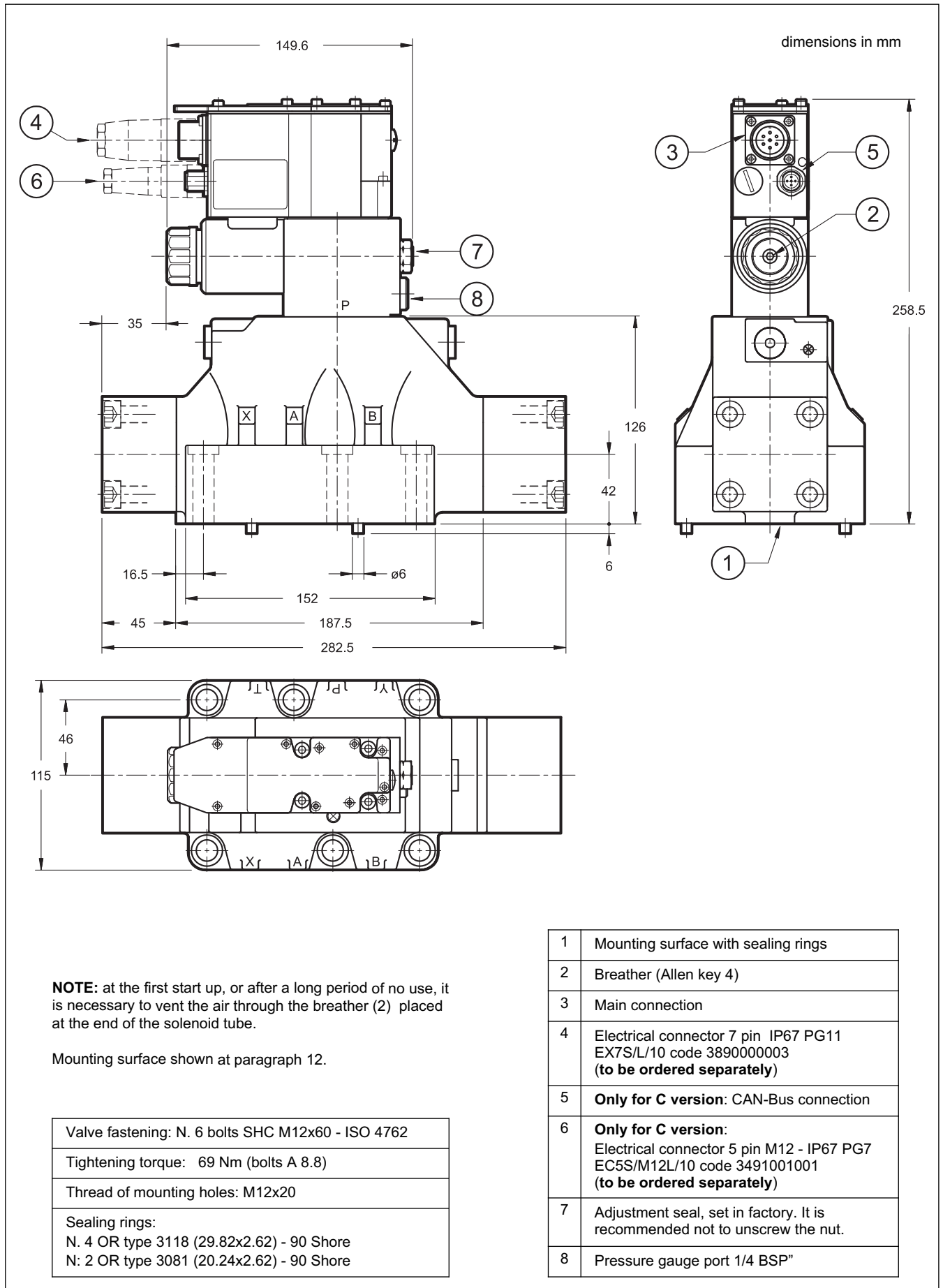



12 - MOUNTING SURFACES

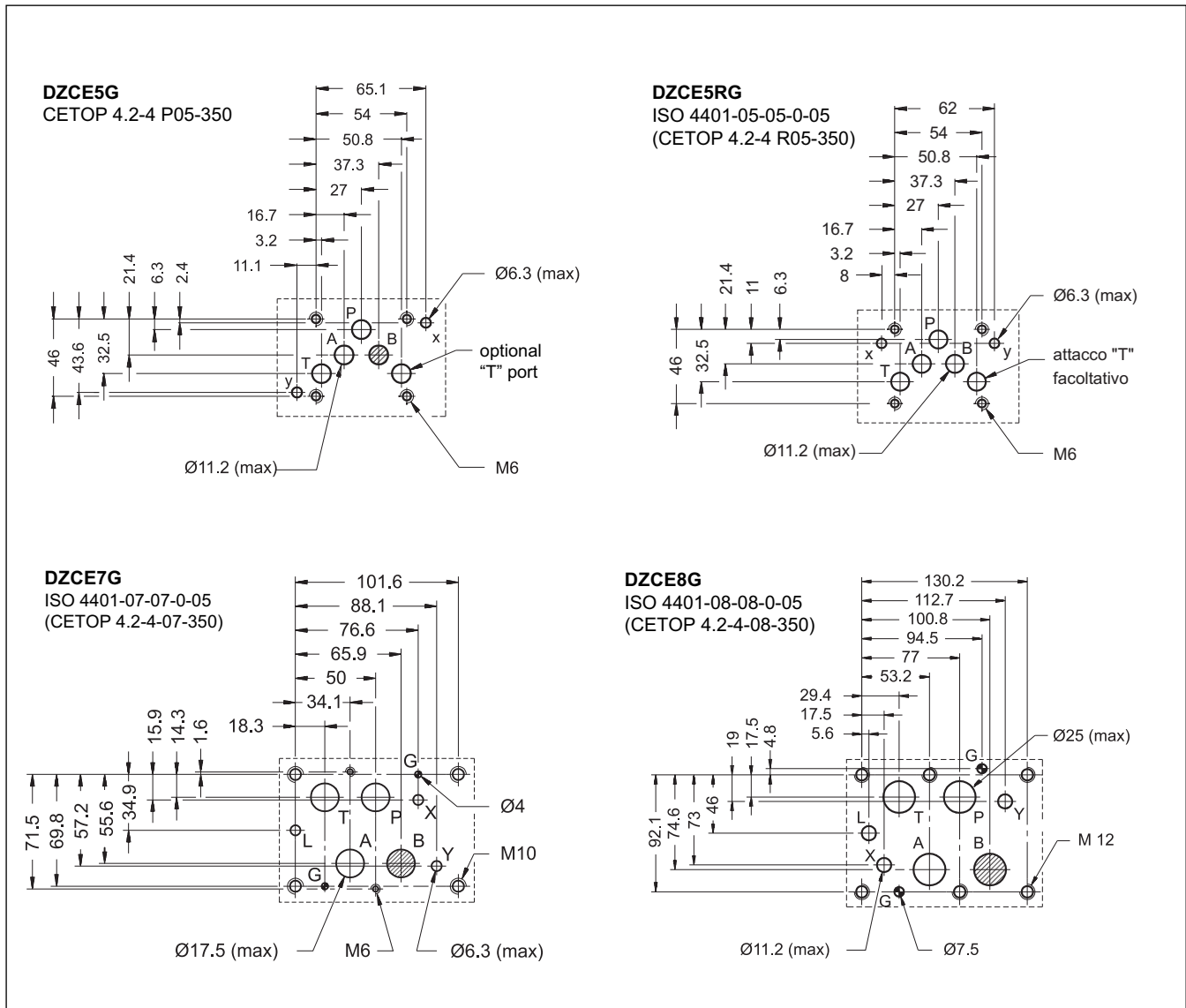

13 - SUBPLATES

(see catalogue 51 000)

	DZCE5G	DZCE7G	DZCE8G
Type with rear ports	PME4-AI5G	PME07-AI6G	-
Type with side ports	PME4-AL5G	PME07-AL6G	PME5-AL8G
Thread of ports:	P - T - A - B X - Y	3/4" BSP 1/4" BSP	1" BSP 1/4" BSP



DIPLOMATICO OLEODINAMICA S.p.A.
 20015 PARABIAGO (MI) • Via M. Re Depaolini 24
 Tel. +39 0331.895.111
 Fax +39 0331.895.339
 www.diplomatic.com • e-mail: sales.exp@diplomatic.com

