



RPC1*/M

FLOW CONTROL VALVE

SERIES 10

MODULAR VERSION

ISO 4401-03 (CETOP 03)

p max 250 bar
Q max (see table of performances)

MOUNTING INTERFACE

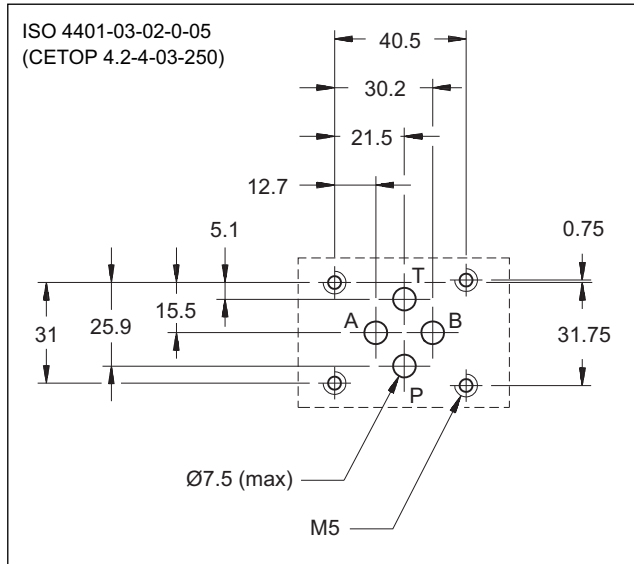

CONFIGURATIONS

(see Hydraulic symbols table and Identification Code - par. 1)

PERFORMANCES (measured with mineral oil of viscosity 36cSt at 50°C)

Maximum operating pressure	bar	250
Maximum flow rate in controlled lines		1-4-10-16-22-30
Maximum flow rate in the free lines	l/min	65
Reverse free flow maximum flowrate		40
Ambient temperature range	°C	-20 / +50
Fluid temperature range	°C	-20 / +80
Fluid viscosity range	cSt	10 ÷ 400
Fluid contamination degree	According to ISO 4406:1999 class 20/18/15	
Recommended viscosity	cSt	25
Mass: RPC1*/M/ A-B-T-P		3
RPC1*/M/ D		4,1
RPC1*/M/PCT3		3,7
only modular block ISO 4401-03 without flow control valves:	kg	
RPC1-K/M/*		1,5
RPC1-K/M/PCT3		2,4

NOTE: for detailed information regarding the RPC1 flow control valve, see catalogue 32 200

OPERATING PRINCIPLE

- The RPC1*/M valve is a flow control valve with pressure and temperature compensation, made as a modular version with mounting surface according to the ISO 4401 (CETOP RP 121H) standards.
- It can be assembled quickly under the ISO 4401-03 (CETOP 03) directional solenoid valves and allows easy execution of hydraulic circuits where control of the speed of the actuators is required.
- It is available in six flow adjustment ranges up to 30 l/min.
- Combined with MDD44 type solenoid operated directional control valves (see cat. 41 250), it's possible to obtain circuits for the fast/slow control of the work actuators.

HYDRAULIC SYMBOLS

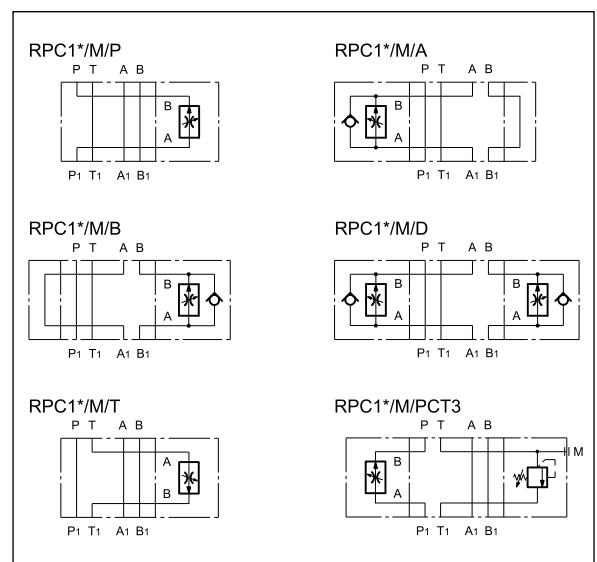

1 - IDENTIFICATION CODE

R	P	C	1	-		/	M	/		-		/	10	/	
----------	----------	----------	----------	----------	--	----------	----------	----------	--	----------	--	----------	-----------	----------	--

Pressure and temperature compensated flow control valve

Flow adjustment range:
1 = 1 l/min **16** = 16 l/min
4 = 4 l/min **22** = 22 l/min
10 = 10 l/min **30** = 30 l/min
K = only ISO 4401-03 (CETOP 03) modular block supplied without flow control valve

Modular version _____
size ISO 4401-03 (CETOP 03)

Seals: omit for mineral oils
V = viton for special fluids

Series No. (the overall and mounting dimensions remain unchanged from 10 to 19)

M1 = adjustment knob only for PCT3 version (omit for adjustment with countersunk hex screw)

Configurations:
P = meter in control on line P
A = control from chamber A of the actuator
B = control from chamber B of the actuator
D = control from chambers A and B of the actuator
T = meter out control on line T
PCT3 = meter in control on line P with backpressure adjustable on line T up to 70 bar
(A and B configurations are not available in **K** version)

2 - CHARACTERISTIC CURVES (values obtained with viscosity of 36 cSt at 50°C)

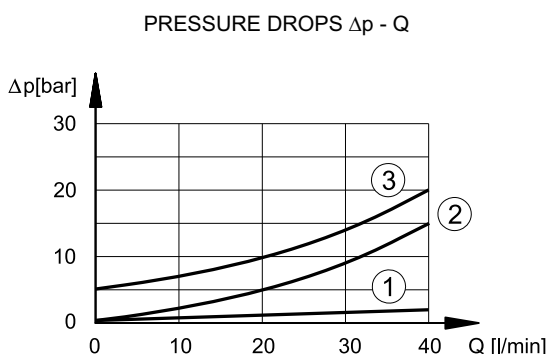
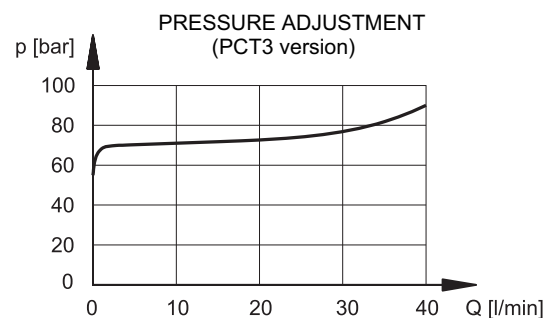
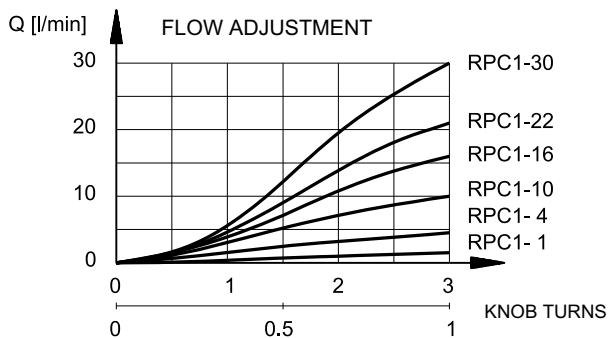

- 1) pressure drops on free lines
- 2) pressure drops through check valve
- 3) pressure drops through the backpressure valve (PCT3 version)

3 - HYDRAULIC FLUIDS

Use mineral oil-based hydraulic fluids HL or HM type, according to ISO 6743-4. For these fluids, use NBR seals. For fluids HFDR type (phosphate esters) use FPM seals (code V). For the use of other kinds of fluid such as HFA, HFB, HFC, please consult our technical department. Using fluids at temperatures higher than 80 °C causes a faster degradation of the fluid and of the seals characteristics. The fluid must be preserved in its physical and chemical characteristics.

4 - OVERALL AND MOUNTING DIMENSIONS RPC1*/M VALVES

dimensions in mm

RPC1*/M/D

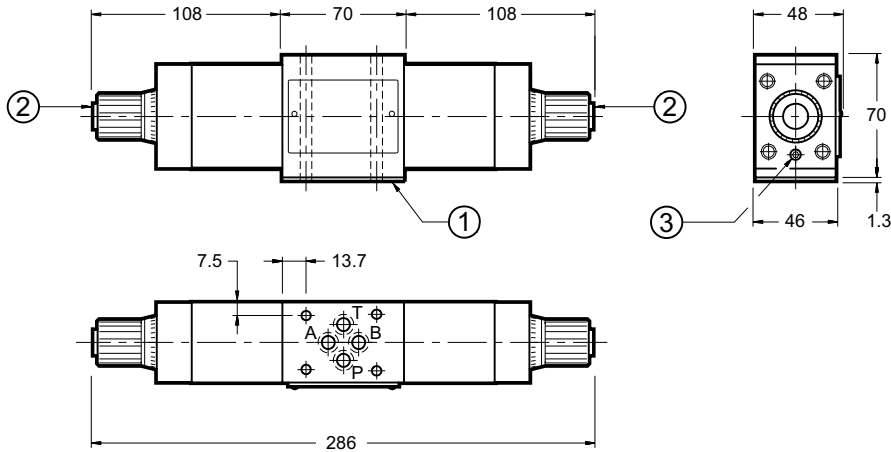

RPC1*/M/P
RPC1*/M/T

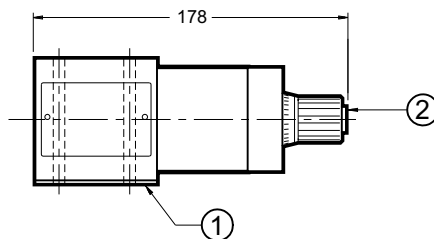

RPC1*/M/A

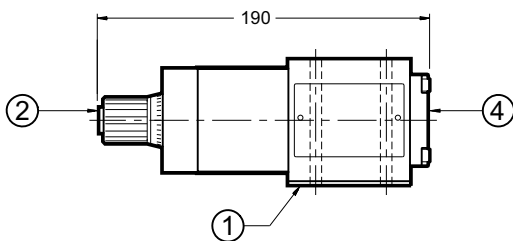

RPC1*/M/B

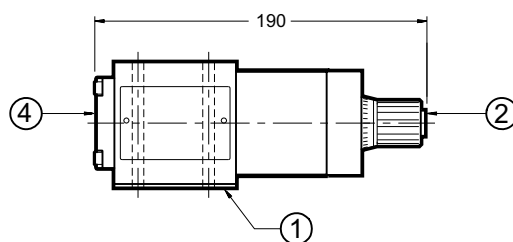

RPC1*/M/PCT3

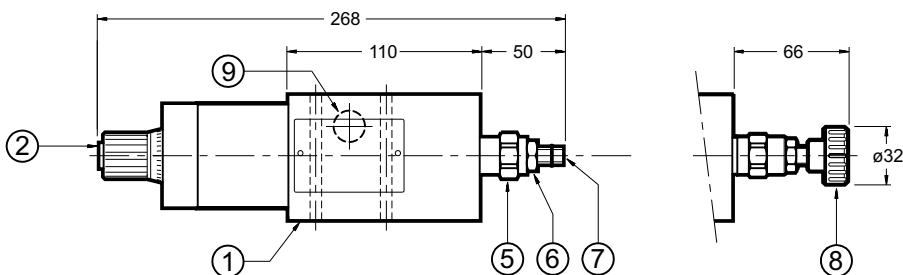

1	Mounting plate with sealing rings: P-OR1L/20N (NBR seals) P-OR1L/20V (Viton seals) For RPC1*/M/PCT3 without mounting plate: 4 OR 2037 (9.25x1.78) - 90 Shore
2	Flow adjustment knob (3 turns total) Rotate anticlockwise to increase flow.
3	Knob locking screw
4	Cross-connection cover
5	Backpressure valve on line T. Pressure adjustment range up to 70 bar
6	Locking nut: spanner 17
7	Countersunk hex screw: spanner 5 Rotate clockwise to increase pressure
8	Adjustment knob: M1
9	Pressure gauge port 1/4" BSP

5 - OVERALL AND MOUNTING DIMENSIONS OF BLOCKS WITHOUT FLOW CONTROL VALVE

dimensions in mm

RPC1-K/M/D

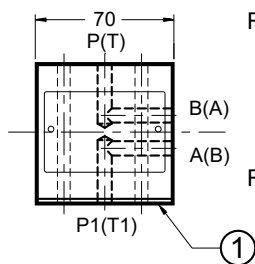
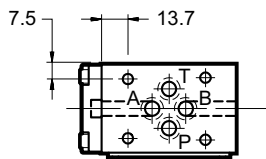
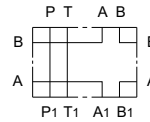
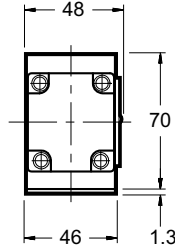
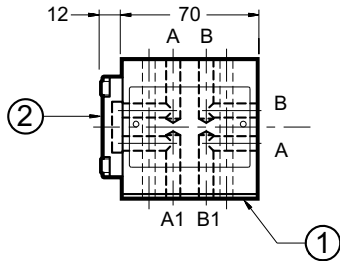

RPC1-K/M/P

RPC1-K/M/T

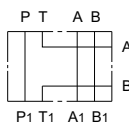
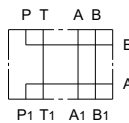

1	Mounting plate with sealing rings: P-OR1L/20N (NBR seals) P-OR1L/20V (Viton seals) For RPC1-*/M/PCT3 without mounting plate: 4 OR 2037 (9.25x1.78) - 90 Shore
2	Cross-connection cover
3	Backpressure valve on line T. Pressure adjustment range up to 70 bar
4	Locking nut: spanner 17
5	Countersunk hex screw: spanner 5 Rotate clockwise to increase pressure
6	Adjustment knob: M1
7	Pressure gauge port 1/4" BSP

RPC1-K/M/PCT3

